



VIBRATION DAMPERS

Highly elastic and tearproof mounts for passive and active vibration dampening

- Vibration-free mounting of motor test stands, emergency generators, compressors, etc.
- Tearproof mounting of suspended loads such as crane tracks and cable car cabins
- Anti-vibration machine leveling feet with balancing ball joints
- Impact-resistant vibration dampers for energy dissipation at belt transfer stations
- Standardised product range for high load capacities

Product advantages:



high degree
of isolation

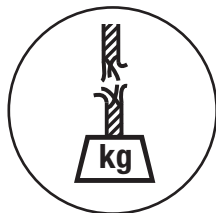









tearproof



maintenance-free

Selection table vibration dampers

	Illustration	Type	Description	Page
Vibration dampers basic types		ESL	Vibration dampers for the absorption of tensile, pressure and shear load. Also ideal for wall and ceiling installations. 8 element sizes from 200 N to 19 000 N. Natural frequency between 3.5–8 Hz. Mounts are mainly used for overcritical machine installations (machine frequency > mount frequency).	4.3
		AWI	Vibration dampers for to absorb tensile and pressure loads. 7 element sizes from 180 N to 16 000 N. Natural frequency between 3–7 Hz. Mounts are mainly used for overcritical machine installations (machine frequency > mount frequency).	4.4
		V	Vibration dampers for the absorption of tensile, pressure and shear load. Also ideal for wall and ceiling installations. 6 element sizes from 300 N to 12 000 N. Natural frequency between 10–30 Hz. Mounts can be used for subcritical machine installations (machine frequency < mount frequency).	4.5
Vibration dampers additional types		N	Mounting feet consisting of insulating plate, top cover with built-in levelling jack-screw with spherical joint for compensation of up to 10° of floor unevenness. Insulating plate oil- and acid-proof. FDA approved. 3 element sizes from 3 500 N to 20 000 N. Natural frequency between 19–27 Hz.	4.6
		NOX	Mounting feet consisting of insulating plate, stainless steel top cover with built-in stainless levelling jackscrew with spherical joint to compensate of up to 10° of floor unevenness. Insulating plate oil- and acid-proof. FDA approved. 2 element sizes from 5 000 N to 20 000 N. Natural frequency between 19–24 Hz.	
		Base plate P	Accessories for N and NOX for high shear forces or for assembling on a base or frame. The base plate must be bolted to the floor.	4.7
		M	Mounting feet consisting of metallic insulating cushion. Cushion resistant against corrosion, greases and solvents. 6 element sizes from 300 N to 35 000 N. Natural frequency between 14–26 Hz.	4.8
		NE	Adhesive cushioning plates made of closed-cell polyether urethane, no water absorption and good oil resistance. 3 element sizes from 500 N to 130 000 N. Natural frequency between 14–25 Hz.	4.9

Vibration damper

ESL

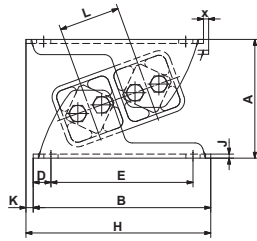

sizes 15 to 45

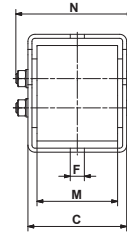

from size 50

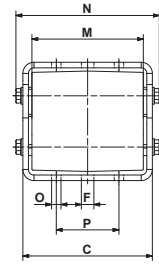

Part no.	Type	Load $G_{min.} - G_{max.}$ [N] on Z-axis	A unloaded	A* max. load	B	C	D	E	$\varnothing F$
05 021 001	ESL 15	200–550	54	43	85	49	10	65	7
05 021 002	ESL 18	450–1250	65	51	105	60	12.5	80	9.5
05 021 003	ESL 27	700–2000	88	68	140	71	15	110	11.5
05 021 004	ESL 38	1300–3800	117	91	175	98	17.5	140	14
05 021 005	ESL 45	2200–6000	143	110	220	120	25	170	18
05 021 016	ESL 50	4000–11000	170	138	235	142	25	185	18
05 021 017	ESL 50-1.6	5500–15000	170	138	235	186	25	185	18
05 021 018	ESL 50-2	7000–19000	170	138	235	226	25	185	18

Part no.	Type	H	J	K	L	M	N	O	P	x max.	Weight [kg]	Natural frequency $G_{min.} - G_{max.}$ [Hz]	Material structure
05 021 001	ESL 15	91	2	5.5	25.5	40	58.5	–	–	1.5	0.3	8.2–5.8	Aluminium profiles, steel brackets, painted blue, zinc-plated couplings
05 021 002	ESL 18	111	2.5	5.5	31	50	69	–	–	1.9	0.6	7.5–5.0	
05 021 003	ESL 27	148	3	8	44	60	85.3	–	–	2.7	1.3	6.2–4.5	
05 021 004	ESL 38	182	4	7	60	80	117	–	–	3.6	3.1	5.5–4.0	
05 021 005	ESL 45	235	5	15	73	100	138	–	–	4.4	5.9	5.0–3.5	
05 021 016	ESL 50	244	6	9	78	120	162	13.5	90	10	8.4	5.0–3.5	
05 021 017	ESL 50-1.6	244	8	9	78	160	206	13.5	90	10	10.4	5.0–3.5	
05 021 018	ESL 50-2	244	8	9	78	200	246	13.5	90	10	14.0	5.0–3.5	

* compression load $G_{max.}$ and cold flow compensation (after approx. 1 year).

If no other units are specified, the numbers given are in mm.

The sizes 50 to 50-2 can be combined with one another (identical heights and operation behaviour).

The max. load on X-axis should not exceed 200% of the Z-axis capacity.

The max. load on Y-axis should not exceed 20% of the Z-axis capacity.

Applicable on tensile, pressure and shear load.

Vibration damper

AWI



AWI R

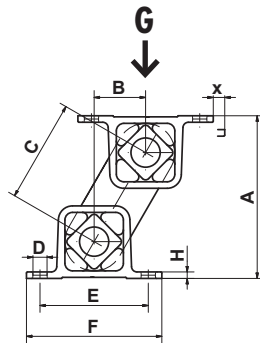

sizes 15 to 27

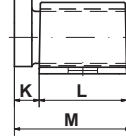

sizes 38 to 50

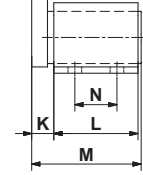

size 50-2

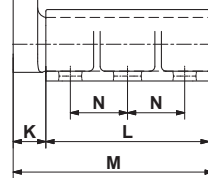

AWI L

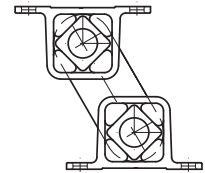

Part no.	Type	Load $G_{min.} - G_{max.}$ [N]	A unloaded	A* max. load	B	C	D	E	F
05 111 101	AWI 15R	180–400	68	55	22.5	45	7×10	50	65
05 121 101	AWI 15L	180–400	68	55	22.5	45	7×10	50	65
05 111 102	AWI 18R	350–850	88	70	30	60	9×15	60	80
05 121 102	AWI 18L	350–850	88	70	30	60	9×15	60	80
05 111 103	AWI 27R	650–1500	111	91	35	70	11×20	80	105
05 121 103	AWI 27L	650–1500	111	91	35	70	11×20	80	105
05 111 104	AWI 38R	1200–3000	150	122	47.5	95	13×20	100	125
05 121 104	AWI 38L	1200–3000	150	122	47.5	95	13×20	100	125
05 111 105	AWI 45R	2000–4800	177	145	55	110	13×26	115	145
05 121 105	AWI 45L	2000–4800	177	145	55	110	13×26	115	145
05 111 106	AWI 50R	4000–9600	194	159	60	120	17×27	130	170
05 121 106	AWI 50L	4000–9600	194	159	60	120	17×27	130	170
05 111 108	AWI 50-2R	6600–16000	194	159	60	120	17×27	130	170
05 121 108	AWI 50-2L	6600–16000	194	159	60	120	17×27	130	170

Part no.	Type	H	K	L	M	N	x max.	Weight [kg]	Natural frequency $G_{min.} - G_{max.}$ [Hz]	Material structure
05 111 101	AWI 15R	3	10	40	52	–	14	0.5	7.2–4.5	Stainless steel casting GX5CrNi19-10 (1.4308)
05 121 101	AWI 15L	3	10	40	52	–	14	0.5	7.2–4.5	
05 111 102	AWI 18R	3.5	14	50	67	–	19	0.9	6.5–3.7	
05 121 102	AWI 18L	3.5	14	50	67	–	19	0.9	6.5–3.7	
05 111 103	AWI 27R	4.5	17	60	80	–	22	1.9	6.0–3.7	
05 121 103	AWI 27L	4.5	17	60	80	–	22	1.9	6.0–3.7	
05 111 104	AWI 38R	6	21	80	104	40	31	4.5	5.2–3.2	
05 121 104	AWI 38L	6	21	80	104	40	31	4.5	5.2–3.2	
05 111 105	AWI 45R	8	28	100	132	58	35	7.8	5.0–2.8	
05 121 105	AWI 45L	8	28	100	132	58	35	7.8	5.0–2.8	
05 111 106	AWI 50R	12	40	120	165	60	38	12.8	4.8–2.8	
05 121 106	AWI 50L	12	40	120	165	60	38	12.8	4.8–2.8	
05 111 108	AWI 50-2R	12	45	200	250	70	38	20.3	4.8–2.8	
05 121 108	AWI 50-2L	12	45	200	250	70	38	20.3	4.8–2.8	

* compression load $G_{max.}$ and cold flow compensation (after approx. 1 year).

If no other units are specified, the numbers given are in mm.

The sizes 50 and 50-2 can be combined with one another (identical heights and operation behaviour).

Vibration damper

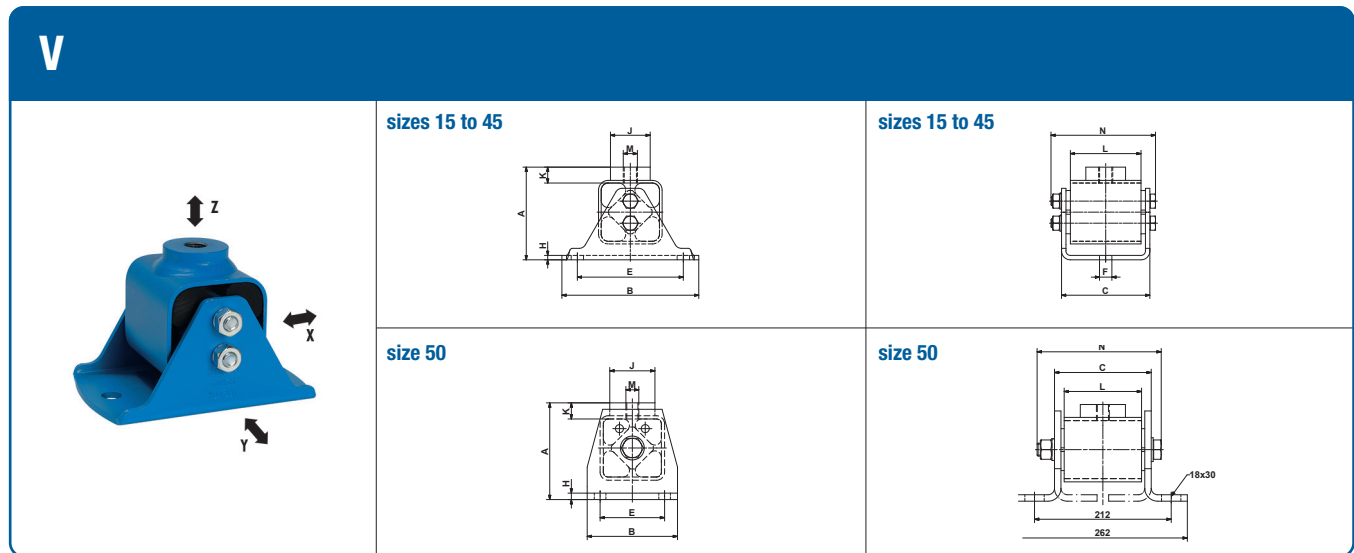

Part no.	Type	Load $G_{min.} - G_{max.}$ [N] on X- and Z-axis	A	B	C	E	ϕF	H	ϕJ
05 011 001	V 15	300–800	49	80	51	55	9.5	3	20
05 011 002	V 18	600–1 600	66	100	62	75	9.5	3.5	30
05 011 003	V 27	1 300–3 000	84	130	73	100	11.5	4	40
05 011 024	V 38	2 600–5 000	105	155	100	120	14	5	45
05 011 005	V 45	4 500–8 000	127	190	122	140	18	6	60
05 011 006	V 50	6 000–12 000	150	140	150	100	–	10	70

Part no.	Type	K	L	M	N	Weight [kg]	Natural frequency $G_{min.} - G_{max.}$ [Hz]	Material structure
05 011 001	V 15	10	40	M10	59	0.3	30–23	Aluminium profile, welded steel housings, painted blue, zinc-plated couplings
05 011 002	V 18	13	50	M10	74	0.6	25–15	
05 011 003	V 27	14.5	60	M12	85	1.2	28–20	
05 011 024	V 38	17.5	80	M16	117	2.5	14–12	
05 011 005	V 45	22.5	100	M20	143	4.5	15–12	
05 011 006	V 50	25	120	M20	193	7.5	12–10	

If no other units are specified, the numbers given are in mm.
 The max. load on Y-axis should not exceed 20% of the X- resp. Z-axis capacity.
 Momentary shock loads of 2.5 g in X- and Z-axis admissible.
 Applicable on tensile, pressure and shear load.
 V 50: Alternativ mounting position 180° turned.

Vibration damper

N / NOX

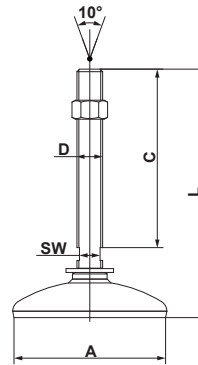

Part no.	Type	Load $G_{min.} - G_{max.}$ [N]	Natural frequency $G_{min.} - G_{max.}$ [Hz]	$\varnothing A$	C	D	L	SW	Weight [kg]	Material structure (rubber pad NBR with 50 ShA)
05 058 021	N 80 M12	3 500–8 000	27–22	80	60	M12	94	14	0.3	galvanised, base painted blue
05 058 022	N 80 M16	5 000–12 000	24–20	80	150	M16	188	13	0.5	galvanised, base painted blue
05 058 122	NOX 80 M16	5 000–12 000	24–20	80	150	M16	188	13	0.5	stainless steel 1.4301 and 1.4305
05 058 024	N 120 M20	8 000–20 000	22–19	120	150	M20	194	17	0.9	galvanised, base painted blue
05 058 124	NOX 120 M20	8 000–20 000	22–19	120	150	M20	194	17	0.9	stainless steel 1.4301 and 1.4305

If no other units are specified, the numbers given are in mm.
N/NOX are FDA approved.

Vibration damper

P

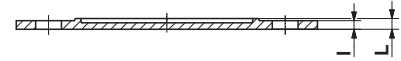
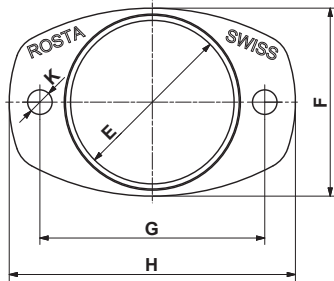

Part no.	Type	Accessory to	$\varnothing E$	F	G	H	I	$\varnothing K$	L	Weight [kg]	Material structure
05 060 101	P 80	N/NOX 80	80	92	110	140	4	12	5	0.1	Aluminium cast
05 060 102	P 120	N/NOX 120	120	135	170	210	5	16	7	0.3	

If no other units are specified, the numbers given are in mm.

Vibration damper

M

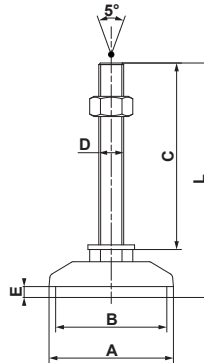

Part no.	Type	Load $G_{min.} - G_{max.}$ [N]	Max. dynamic load [N]	Deflection with $G_{max.}$ approx. [mm]	Natural frequency [Hz]	ϕA	ϕB	C	D	E	L	Weight [kg]
05 158 001	M 43 M16	300–2500	12500	3.0	20–26	80	61	120	M16	7	151	0.7
05 158 002	M 44 M16	2000–27000	70000	3.0	20–26	80	72	120	M16	7	151	0.7
05 158 003	M 45 M20	5000–35000	75000	3.0	20–26	128	119	120	M20	8	157	1.8
05 158 011	M 43W M16	300–2500	12500	6.0	14–19	80	63	120	M16	11	155	0.6
05 158 012	M 44W M16	1000–13000	45000	6.0	14–19	80	71	120	M16	18	162	0.7
05 158 013	M 45W M20	2000–25000	60000	6.0	14–19	128	120	120	M20	18	168	1.9

If no other units are specified, the numbers given are in mm.

Insulates structure-borne noise.

Chrome-steel cushion temperature resistant -40°C to $+250^{\circ}\text{C}$.

Resistant against corrosion, greases and solvents.

Up to 3 g dynamic shock loading permissible.

Unlimited lifetime.

On request available stainless steel anti-slip soles with granules on the underside:

- Part no. 04 020 451 for M 43 M16 and M 43W M16
- Part no. 04 020 452 for M 44 M16 and M 44W M16
- Part no. 04 020 453 for M 45 M20 and M 45W M20

Vibration damper

NE

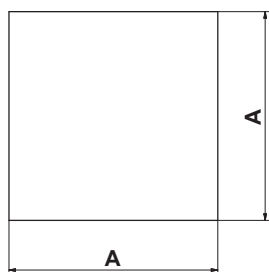

Part no.	Type	Load $G_{min.} - G_{max.}$ [N]	Deflection $G_{min.} - G_{max.}$ [mm]	Natural frequency $G_{min.} - G_{max.}$ [Hz]	A	B	Weight [kg]	Material structure
05 100 901	NE 50-12	500–1 500	0.5–1.4	25–14	50	12.5	0.02	– Polyether-Urethane closed-cell – No water absorption – Working temperature –30 to +70 °C – Good oil-resistance
05 100 902	NE 80-12	1 500–4 500	0.5–1.4	25–14	80	12.5	0.06	
05 100 903	NE 400-12	44 000–130 000	0.5–1.4	25–14	400	12.5	1.54	

If no other units are specified, the numbers given are in mm.

Tolerances according to ISO3302-1:1999 class L3 and EC3. The deflection of the cushions by the mentioned max. catalogue load capacities is 1.4 mm.

VIBRATION DAMPERS



Vibration dampers

Isolation of oscillations and shocks

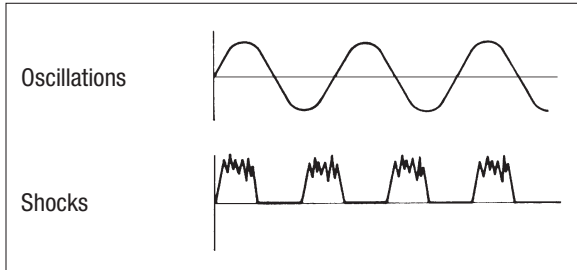

Manufacturers of vibration dampers usually offer different designs of machine mounts with varying natural frequencies, to meet the required detuning between the excitation frequency of the machine to be mounted and the natural frequency of the damper.

The vibration technology basically differentiates between two different oscillation patterns. Oscillations are usually eradicated with supercritical designed machine mounts, while shocks are eradicated with subcritical ones.

Frequency proportion λ

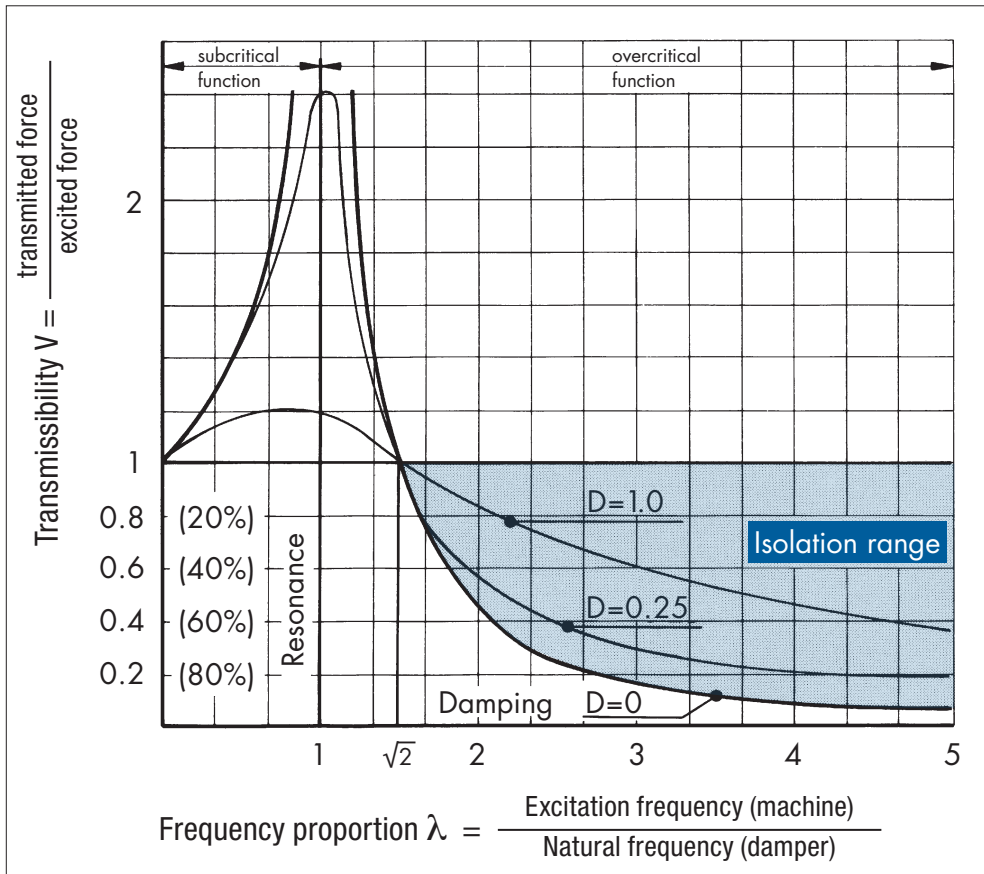

- $\lambda > \sqrt{2}$: Overcritical: vibration isolation, definable effectiveness W , and efficient structure-borne sound insulation
- $\lambda = 1$: Resonance range: amplified resonance, maximum values depend on the internal insulation D within the resonance range
- $\lambda < 1$: Subcritical: no definable vibration isolation and lower structure-borne sound insulation

Vibration dampers

Overcritical installations ($\lambda > \sqrt{2}$)

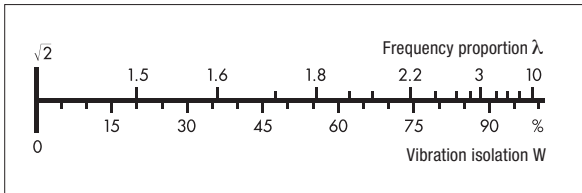

For overcritical mounts, the natural frequency values of the mounts must be at least $\sqrt{2}$ below the excitation frequencies of the machine or unit. As a rule, a damper with a relatively large spring deflection performance under load is selected. Most units, compressors, motors, blowers and generators are mounted overcritical making them relatively «soft». The resulting frequency ratio provides information about the expected isolation effectiveness of the mount. The line scale opposite and the calculation give the expected insulation W as a %.

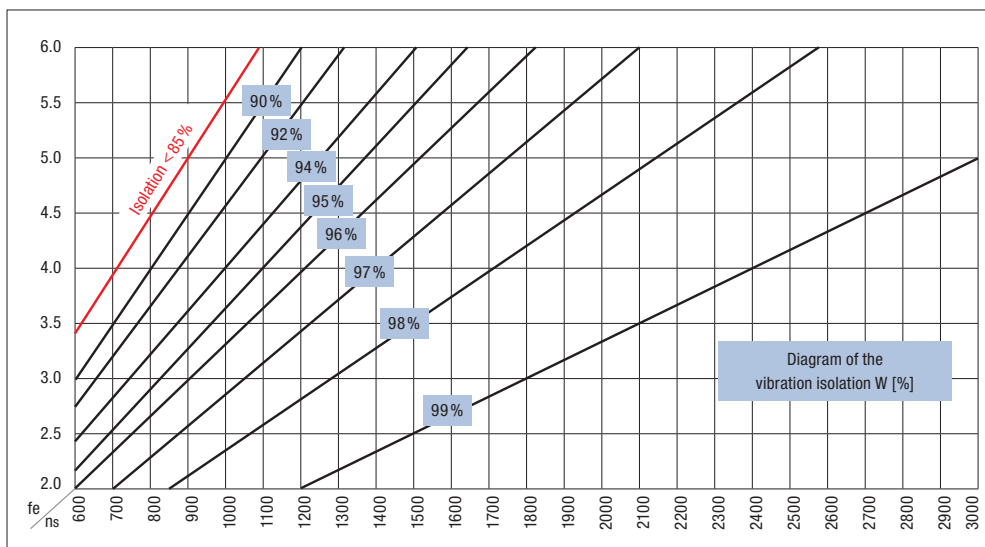

$$W = 100 - \frac{100}{\left(\frac{n_s}{60 \cdot f_e}\right)^2 - 1} [\%]$$

n_s =
Revolution exciter
(machine) [rpm]

f_e =
Natural frequency damper
[Hz]

Subcritical installations ($\lambda < 1$) and resonance range ($\lambda = 1$)

Subcritical installations

A damper with high mechanical strength and low deflection behaviour (high mounting stability) is usually used on subcritical mounts. With this type of mounting, it is possible to damp impacts and shocks from relatively slow-moving machines such as mixers, crushers (cone crushers), punching presses, shears, etc. On machines with subcritical mounts, the resulting efficacy of the isolation insulation cannot be calculated – it can only be determined by comparing the values before and after.

Resonance range

Any coincidence between the exciter frequency and the natural frequency of the damper lead to an undesired, uncontrollable swinging up of the machine to be stored.

Vibration dampers

ESL: Deflection curves and setting behaviour

The deflection graphs already contain an initial cold flow that occurs after the first hours of operation. The final cold flow is approx. $s \times 1.09$. These deflection values are based on our catalogue data and are to be taken as guidelines. Please also refer to our tolerance data in chapter 7 «Technology – ROSTA Basics».

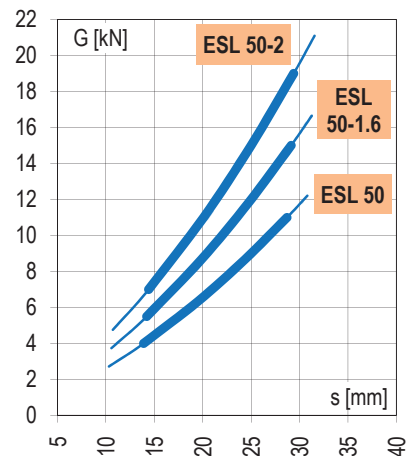
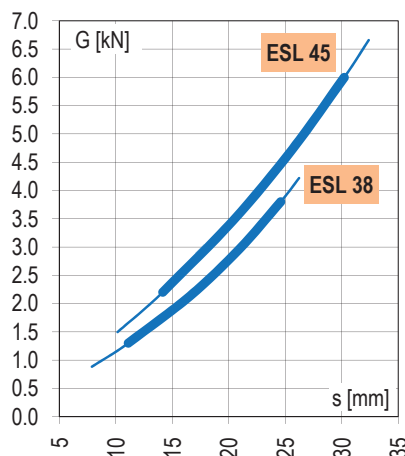
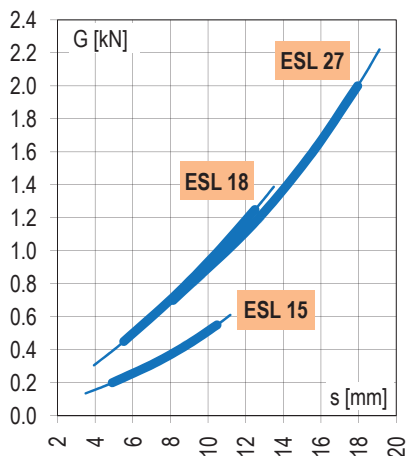

ESL: Installation guidelines

The ESL elements must generally be installed in the same direction.

Dynamic forces longitudinal

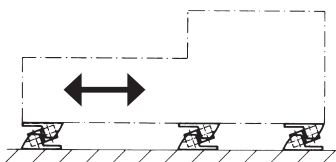

Dynamic forces lateral

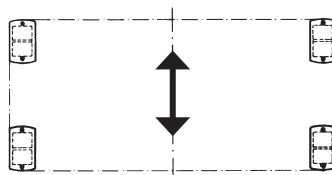

Wall mounting

(Please follow mounting direction)

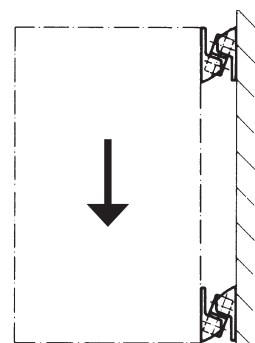

Vibration dampers

ESL: Transfer stations in belt conveyor systems

Size and quantity of ESL for the absorption of the occurring kinetic energy

Weight biggest lump [kg]	Drop height [m]																		
	1.0	1.5	2.0	2.5	3.0	3.5	4.0	4.5	5.0	5.5	6.0	6.5	7.0	7.5	8.0	8.5	9.0	9.5	10.0
5	4	4	4	4	4	4	4	4	4	4	4	4	4	4	4	4	4	4	4
10	4	4	4	4	4	4	4	4	4	4	4	4	4	4	4	4	4	4	4
20	4	4	4	4	4	4	4	4	4	6	6	6	6	6	6	6	6	6	6
30	4	4	4	4	4	6	6	6	6	6	6	6	6	6	8	8	8	8	8
40	4	4	4	4	6	6	6	6	6	6	8	8	8	8	6	6	6	6	6
50	4	4	4	6	6	6	6	6	8	8	8	6	6	6	6	6	6	8	8
60	4	4	6	6	6	6	8	8	8	6	6	6	6	6	8	8	8	8	8
70	4	6	6	6	6	8	8	6	6	6	6	6	8	8	8	8	8	8	8
80	4	6	6	6	8	8	6	6	6	6	8	8	8	8	8	8	8	8	8
90	4	6	6	6	8	6	6	6	6	8	8	8	8	8	8	8	8	8	8
100	4	6	6	8	8	6	6	6	8	8	8	8	8	8	8	8	8	8	8
110	6	6	6	8	6	6	6	8	8	8	8	8	8	8	8	8	8	10	10
120	6	6	8	8	6	6	8	8	8	8	8	8	8	8	8	10	10	10	10
130	6	6	8	6	6	6	8	8	8	8	8	8	8	8	10	10	10	10	12
140	6	6	8	6	6	8	8	8	8	8	8	8	8	10	10	10	10	12	12
150	6	6	8	6	6	8	8	8	8	8	8	8	10	10	10	12	12	12	12
200	6	8	6	8	8	8	8	8	8	10	10	12	12	12	14	14	16	16	16
300	8	6	8	8	8	10	10	12	12	14	16	16							
400	6	8	8	8	10	12	14	16	16										
500	8	8	8	10	12	14	16												

Type	Max. absorption of energy per ESL
ESL 38	250 Nm
ESL 45	375 Nm
ESL 50	750 Nm
ESL 50-1.6	1 000 Nm
ESL 50-2	1 250 Nm

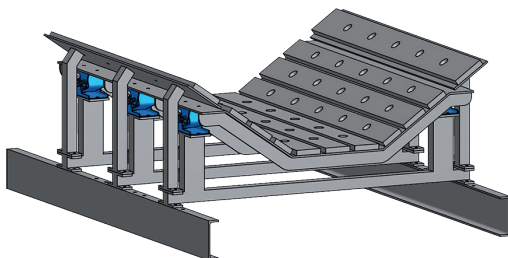

Transfer stations equipped with ROSTA Type ESL vibration dampers offer a progressive deflection characteristic that effectively dampens the kinetic energy created when the falling material makes impact. This protects the surface of the belt's coating from cracking, dramatically reduces the level of continuous material wear and protects the substructure from premature failure.

Vibration dampers

AWI: Deflection curves and setting behaviour

The deflection graphs already contain an initial cold flow that occurs after the first hours of operation. The final cold flow is approx. $s \times 1.09$. These deflection values are based on our catalogue data and are to be taken as guidelines. Please also refer to our tolerance data in chapter 7 «Technology – ROSTA Basics».

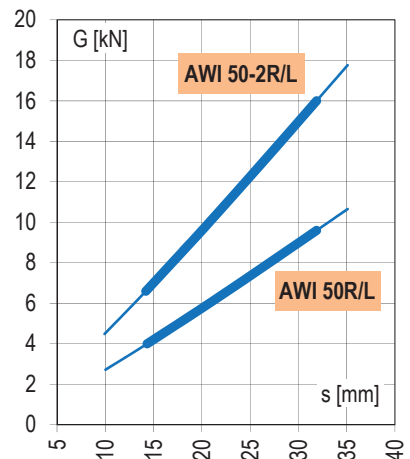
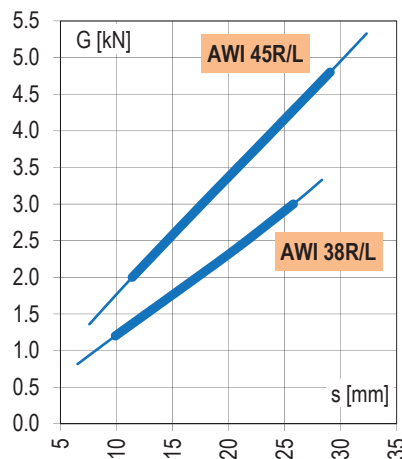
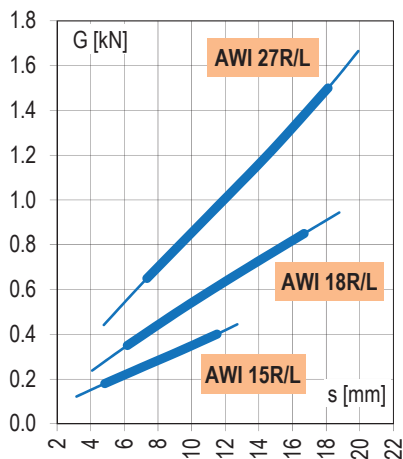

AWI: Installation guidelines

The AWI elements must generally be installed in the same direction.

Dynamic forces longitudinal

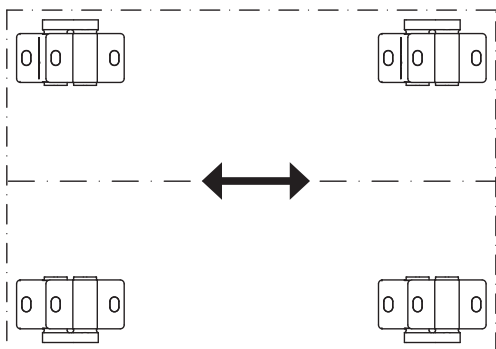

Dynamic forces lateral

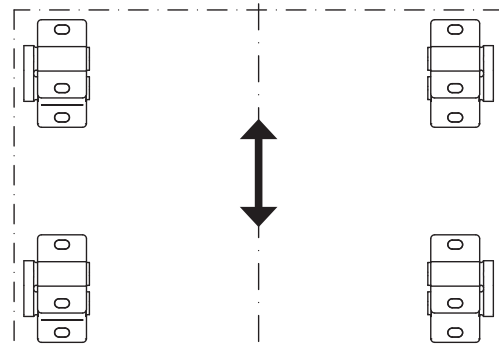

Vibration dampers

V: Deflection curves and cold flow behaviour

These deflection values are based on our catalogue data and are to be taken as guidelines. Please also refer to our tolerance data in chapter 7 «Technology – ROSTA Basics».

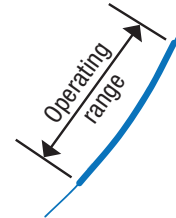
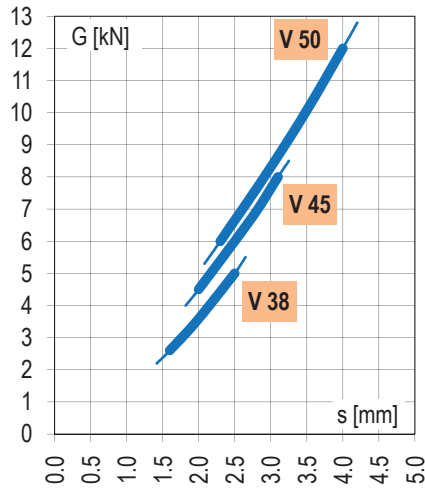
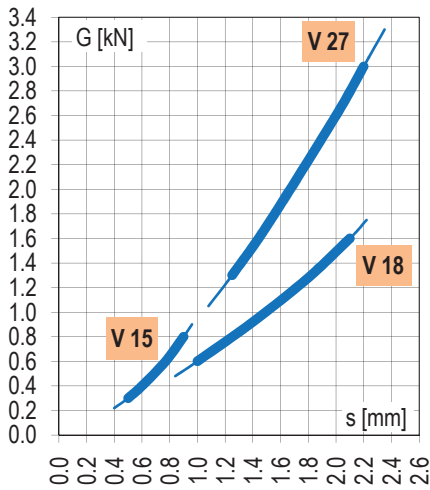

V: Installation guidelines

The V elements installed in the same direction hold load to G_{max} in X- and Z-direction.

Dynamic forces longitudinal

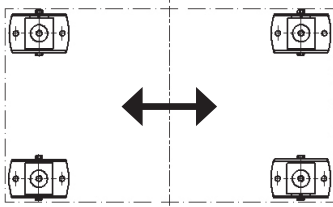

Dynamic forces lateral

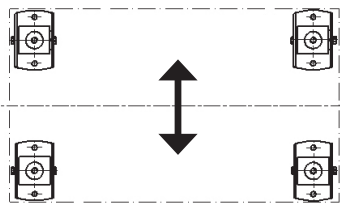

45° diagonal configuration by rotary motions. Reduced load capacities.

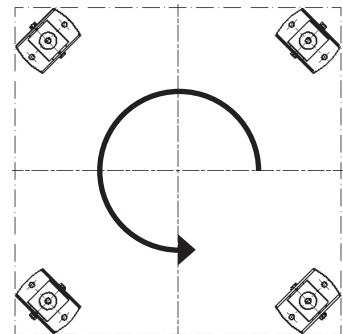

Vibration dampers

NE: Maximum load and options

Maximum load sizes NE 50-12 to 400-12:

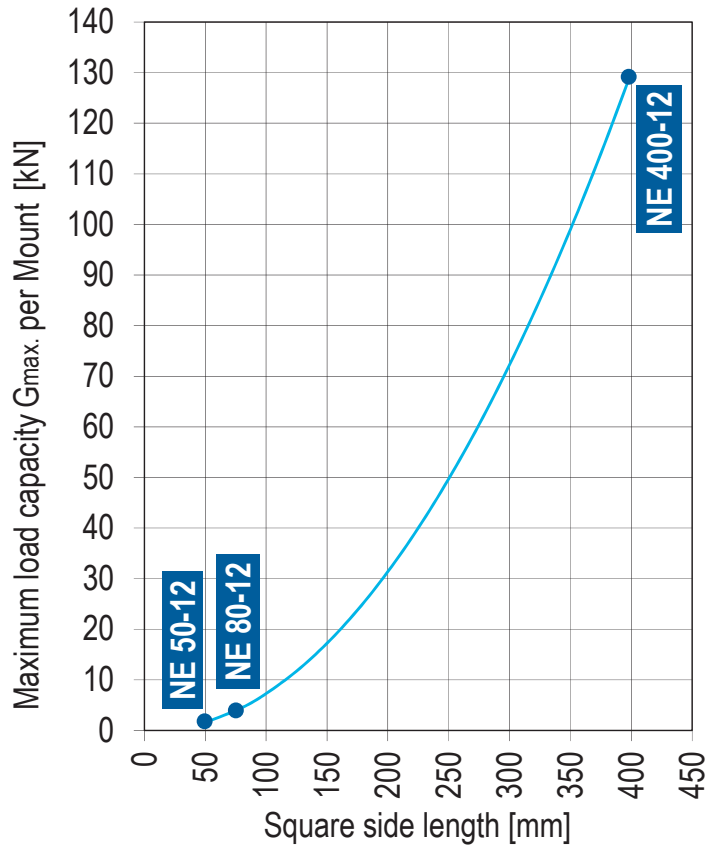

Options on request:

- Adhesive layer
- Different length and width, maximum dimensions are 1.5 × 5 m.
- Material thickness of 8, 12.5 and 25 mm; multiple thickness 37.5 and 50 mm.